

2.0L 水泵 2.0L Water Pump

型号 model: PV-WP46-BA24-A2

产品照片 Photo:



特性曲线 Characteristic curve:

产品尺寸 Dimension:

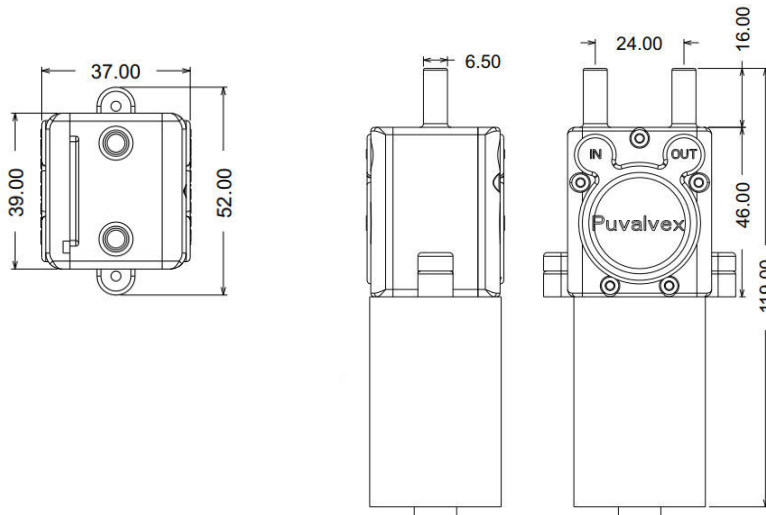

产品性能: Characteristic:

额定电压	Rated voltage	DC12-24V
最大出水压	Maximum outlet pressure	2bar
最大流量	Maximum flow	2000ml/min
寿命测试	Life test	>1000H(8s on, 2s off)
扬程	Head of delivery	>5M
吸程	Suction head	>1M
噪音	Noise	<65db

产品特性 Product feature:

1. 专利产品,
2. 性能稳定, 长寿命, 测试后流量压力衰减小
3. 出水压力大, 流量大
4. 防杂志防污性能好, 可抽果粒橙等颗粒液体